

PARTS



FULL NUT (6)



JAM NUT(6)



WASHER (6)



HINGE NUT (1)

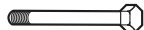

HINGE BOLT (1)

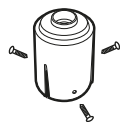

REVOLVING TRUCK (1) WITH SCREWS (3)

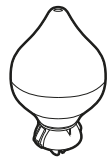

FINIAL (1)

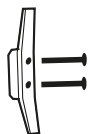

CLEAT (1) WITH SCREWS (2)



FLAG CLIPS (2)



HALYARD (1)

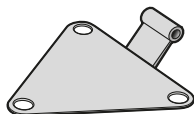

BASE PLATE (1)



THREAD RODS (3)

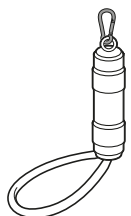

COUNTERWEIGHT (1) & RETAINING RING (1)

ISS-PARTS

(For internal halyard)



STOP BALL (1)



KEYS (2) (only with ISS lock)

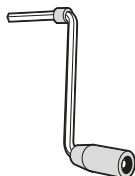

CRANK (1) (only with ISS exclusive)

CARING FOR YOUR FORMENTA FLAGPOLE

Check that nuts are tight and make sure halyard is in good shape on a regular basis (especially when using internal halyard).

When needed, wash the flagpole using hot water and soft soap. Use car wax to maintain the finish.

IMPORTANT! When flying a vertical banner with the internal halyard system, plastic slings must be used (one per meter). Also recommended for external halyarads.

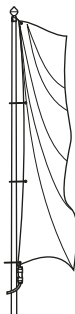

INSTALLATION INSTRUCTIONS

FLAGPOLE 5-12 m

FORMENTA

Box 525, SE-331 25 Värnamo, Sweden
+46 (0)370 - 692550
www.formenta.se



1 FOUNDATION & BASE

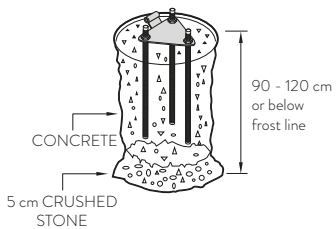

HOLE PREPARATIONS

1. Dig hole according to chart recommendation. If the ground is soft or sandy, increase the diameter of the hole.
2. Fill bottom 5 cm of hole with crushed stone.
3. Fill hole with concrete. Give the top a convex shape to allow for water runoff.

HOLE DIMENSIONS

FLAGPOLE	5-6 m	8 m	9 m	10 m	12 m
Diameter (cm)	35	35	40	45	45
Depth (cm)	90	90	100	120	120

* Recommended dimensions for normal ground conditions. We recommend digging the hole by hand.



ASSEMBLING GROUND SET

1. Secure lower hinge plate (B) to anchor rods by first threading down bottom jam nuts (C) 75 mm (very important), placing over hinge plate and securing top jam nuts (C).
2. Once the base is complete and hole is filled with concrete, insert ground set while gently moving it back and forth, using small movements. Base plate should sit right on top of concrete. Make sure hinge is in a position to allow for raising and lowering of the flagpole without obstructions.

INSTALLING ON ROCK

When installing on rock, assemble the base plate with the thread rods (M20). Use the base plate as a template for hole drilling. Recommended hole diameter is 30-40 mm; 300 mm deep. Shorten thread rods if needed. Mold the base in the holes using expanding concrete or anchor compound.

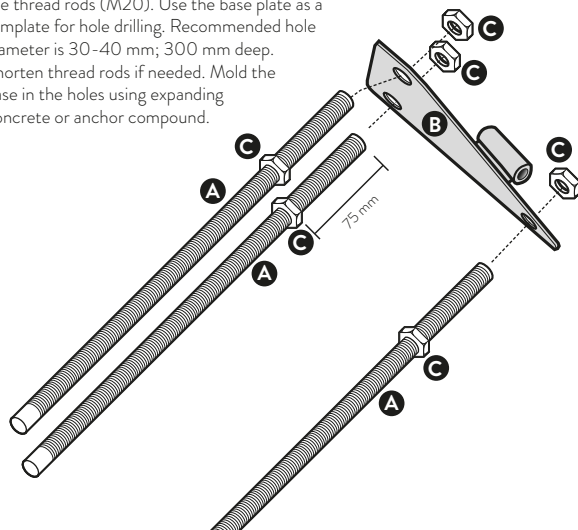

2 FINIAL & HALYARD

1. Attach the finial (B) to the revolving truck (C) by pushing them together until you hear a clicking sound. Fasten finial/truck to top of flagpole using the three supplied screws (D). Make sure the screws don't have any sharp ends from the screwdriver. Thread halyard (A) through finial (B). Attach clips (E) in halyard ends (for ISS, only one clip as below).
2. For external halyard, fasten cleat (F) to flagpole.
3. For ISS (internal halyard), assemble the counterweight (G) according to instructions and attach clips (E) and stop ball (H) to end of halyard.

When using a winch system it's very important to turn in the right direction and that the counterweight responds to crank motion.

EXTERNAL HALYARD

ISS - INTERNAL HALYARD

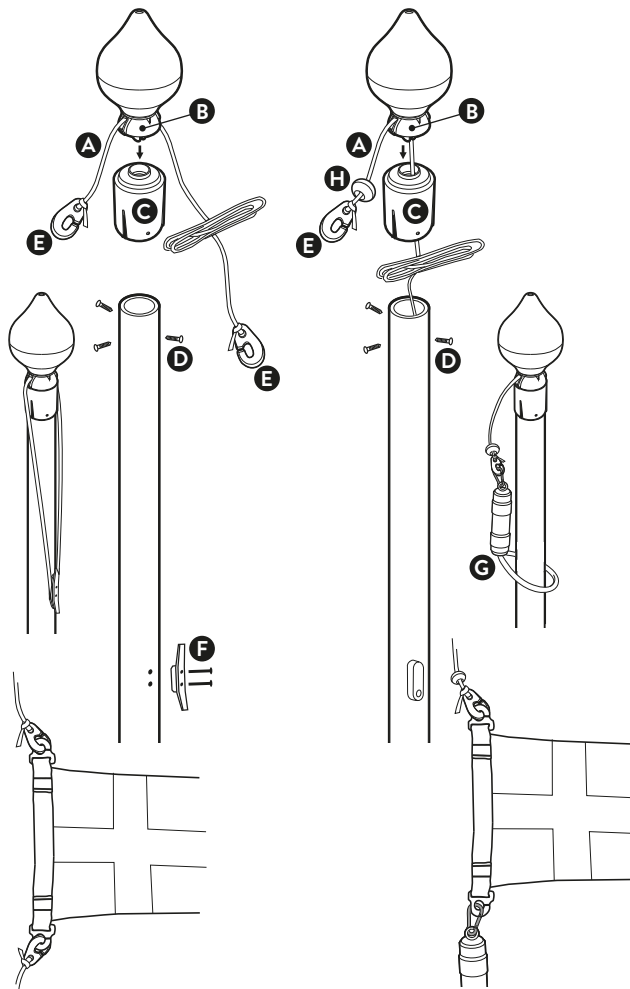

3 RAISING THE FLAGPOLE

1. When the concrete is firmly set, the flagpole can be raised. Thread lower full nuts (F) and washers (G) onto thread rods leaving 12 mm of exposed rod between full nut (F) and jam nut (C). Ensure levelness from nut to nut using a spirit-level and adjust if needed. Bring base of flagpole to lower base plate and fasten with hinge bolt (H).
2. Raise the flagpole. Place washers (I) and thread top full nuts (J). Adjust levelness through slight adjustments to nuts (F and J). DRAW TIGHT.

NOTE: After a few weeks, tighten all nuts as required.

